

G-8049H-1L1C-T

Finezza Uno Series

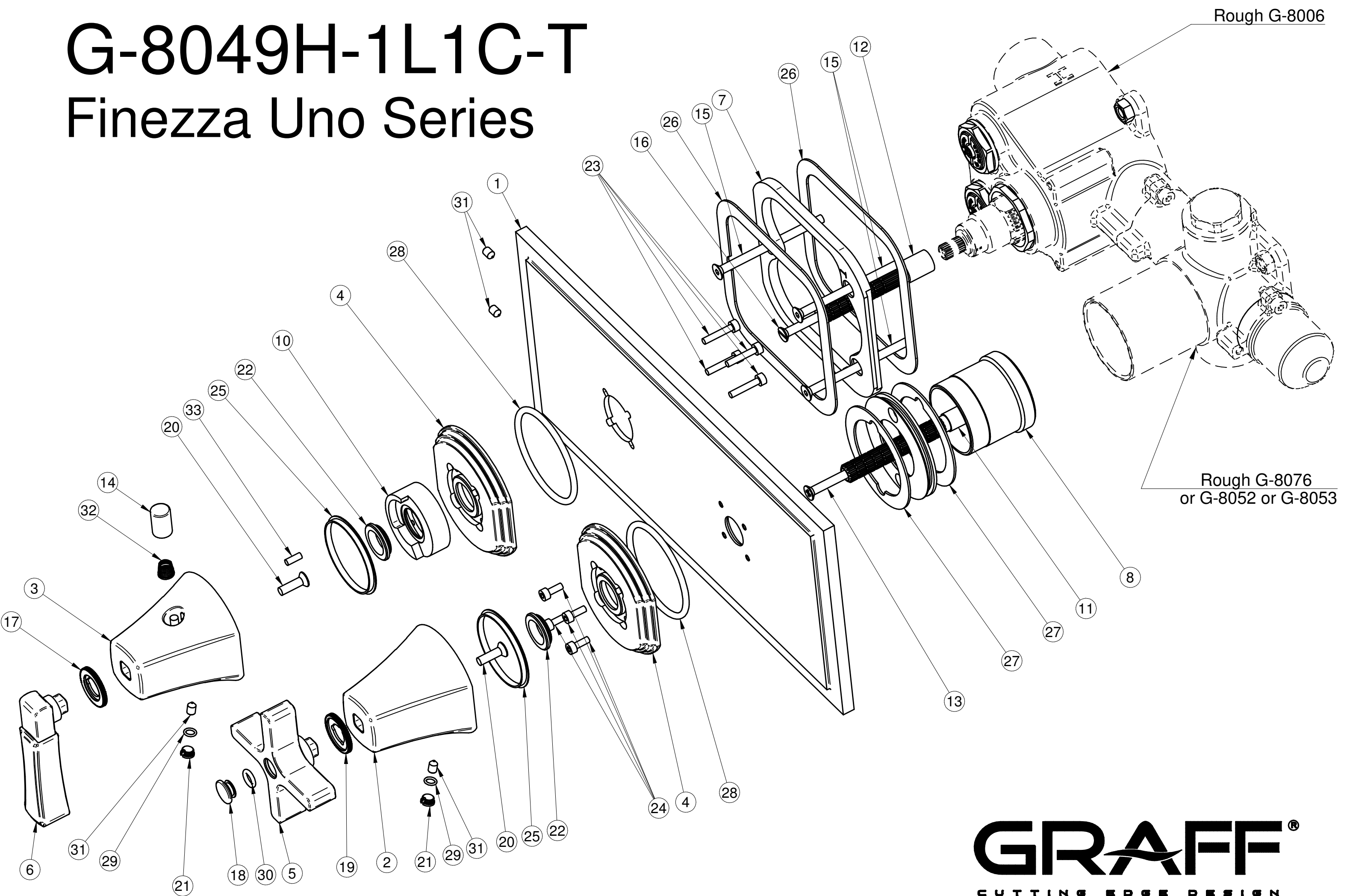

GRAFF[®]
CUTTING EDGE DESIGN